



WARNING

Before troubleshooting any CEN products, the service technician should:

- read, understand, and agree to follow all information contained in this troubleshooting guide.
- understand the operational characteristics of the electrical charging system components to be tested.
- be proficient at the use of tools and test equipment used in troubleshooting CEN products.

Hazard Definitions

These terms are used to bring attention to presence of hazards of various risk levels or to important information concerning product life.

WARNING

Indicates presence of hazard(s) that can cause severe personal injury, death, or substantial property damage if ignored.

CAUTION

Indicates presence of hazards that will or can cause minor personal injury or property damage.

Table of Contents

Section A: Description and Operation..... 2-3
 Section B: Schematic Diagram 4
 Section C: On-Vehicle Troubleshooting 5-7

Tools and Equipment

- Digital Multimeter (DMM)
- Ammeter (digital, inductive)
- Jumper wires
- CEN 6-pin Inline Harness Test Tool A10-114

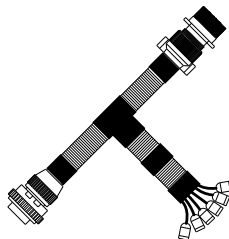

Figure 1—CEN 6-pin Inline Harness Test Tool A10-114

Testing Guidelines

Professional service technicians rely on the following guidelines when testing electrical components.

Voltage testing:

- Set meter to proper scale and type (AC or DC).
- Be sure to zero the meter scale or identify the meter burden by touching meter leads together. Meter burden must be subtracted from final reading obtained.
- Be sure the meter leads touch source area only. Prevent short circuit damage to test leads or source by not allowing meter leads to touch other pins or exposed wires in test area.
- Be sure to use CEN tools designed especially for troubleshooting CEN alternators when available. See page 1 for more information.

Resistance (ohm) testing:

- Set meter to proper scale.
- Be sure to zero the meter scale or identify the meter burden by touching meter leads together. Meter burden must be subtracted from final reading obtained.
- Be sure the meter leads touch source area only. Prevent altering the reading by not allowing fingers or body parts to touch meter leads or source during reading.
- Be sure reading is taken when source is at 70°F. Readings taken at higher temperatures will increase the reading. Conversely, readings taken at lower temperatures will decrease the reading.
- Be sure to test directly at the source. Testing through extended harnesses or cable extensions may increase the reading.

Voltage drop testing:

- Measure voltage between B+ on alternator or source and B- (ground) on alternator or source. Record obtained reading. Move to batteries or other source and measure again between B+ and B- terminals on battery or other source. Difference between the two readings represents voltage lost within the circuit due to but not limited to inadequate cable gage or faulty connections.
- Voltage drop measurements must be taken with all electrical loads or source operating.

Dynamic/Live testing:

Definition: Connecting power and ground to a component to test operation/function out of circuit.

1. Be sure to connect jumper leads directly and securely to source contacts of the component being tested.
2. Be sure to make any connection to power and ground at the power supply or battery source terminals. Do not make connection at component source terminals as that may create an arc and damage component source terminals.



CEN C703/C703A and C706 Alternators/Regulators Description and Operation

C703/C703A 28 V (350 A) and **C706** 28 V (300 A) alternators are internally rectified. All windings and current-transmitting components are non-moving, so there are no brushes or slip rings to wear out.

These alternators are externally energized when the battery master switch on the vehicle is turned on and provides power to the regulators through the IGN circuit (the A2-341 regulator can also operate without vehicle connection to IGN, and instead provide power by sensing rotation through the regulator's AC circuit).

Field coil is then energized. AC is rectified into DC output through diodes in drive end rectifier housing and supplied to the battery from the alternator B+ terminal. See schematic diagram on page 4. Alternator output current is self-limiting and will not exceed rated capacity of alternator. Regulator maintains alternator output voltage at pre-determined regulated setting (see Table 1 or 2 below for setpoints) as vehicle electrical loads are switched on and off.

Battery type selection and battery maintenance/function are the sole responsibilities of the customer.

A2-214 and **A2-325** regulators furnished with some units include:

- External IGN terminal for energize connection.
- P terminal that can provide optional AC voltage tap. P terminal signal frequency (Hz) x 10 = alternator shaft rpm.
- D+ terminal that can provide DC voltage signal to vehicle electrical system, confirming alternator operation.
- Overvoltage cutout (OVCO) function. See page 5.
- (A2-214 only) Green-lensed LED. See page 5.
- (A2-325 only) Tricolored LED. See page 5.
- Regulator fixed (flat temperature compensation) setpoints shown in Table 1 are selected based on battery type.

Table 1 — A2-214 & A2-325 Regulator Setpoint Switch Position		
Voltage Setpoints (± 0.2 V)		Battery Type
Position 1	27.5 V	Maintenance
Position 2	28.0 V	Maintenance
Position 3	28.5 V	Maintenance-free
Position 4	29.0 V	Maintenance-free

Note on Group 31 batteries: If boiling or excessive gassing occurs with high voltage setpoint (position 3), change to medium voltage setpoint (position 2).

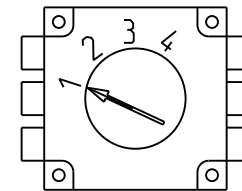

Figure 2—Voltage Setpoints

A2-341 regulator furnished with some units includes:

- External IGN terminal that can provide optional external energize connection. This regulator can function with or without vehicle ignition. When necessary, regulator IGN terminal can be connected to vehicle ignition source to provide battery voltage when engine is running. Circuit should be off (no voltage present) when vehicle ignition is off or engine is not running.
- P terminal that can provide optional AC voltage tap. P terminal signal frequency (Hz) x 10 = alternator shaft rpm.
- D+ terminal that can provide DC voltage signal to vehicle electrical system, confirming alternator operation.
- Overvoltage cutout (OVCO). See page 6.
- Tricolored LED. See page 6.
- Temperature-voltage sense/J1939 harness connector that can be used with optional harness.
 - When optional temperature-voltage sense/J1939 harness is not connected, regulator will operate in fixed voltage setting determined by the select switch position on the bottom of the regulator. See Column 2 in Table 2.
 - When optional temperature-voltage sense/J1939 harness is connected, regulator will automatically optimize the charge voltage for battery type based on temperature. Also, vehicle manufacturer-requested functions of J1939 interface are available through connector. See Column 3 in Table 2.

Table 2 — A2-341 Regulator Voltage/Battery Switch Position		
Switch Position	T-VS/J1939 Harness Not Connected (Voltage Select)	T-VS/J1939 Harness Connected (Battery Select)
Position 1	27.5 V	Maintenance (D Category)
Position 2	28.0 V	Maintenance-free (Group 31)
Position 3	28.5 V	AGM
Position 4	29.0 V	DO NOT USE POSITION # 4

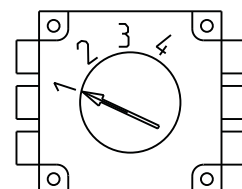
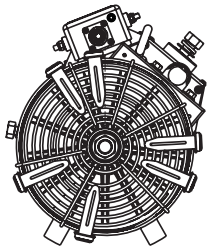

Figure 3—Voltage/Battery Switch



Section A: Description and Operation (CONT'D)



C703 ADE View

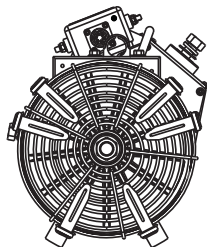

C703A ADE View

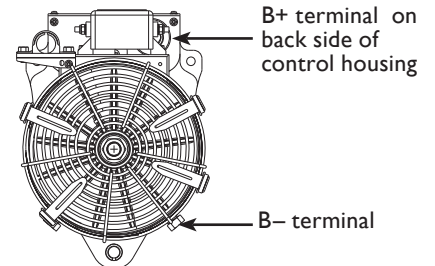

C706 ADE View

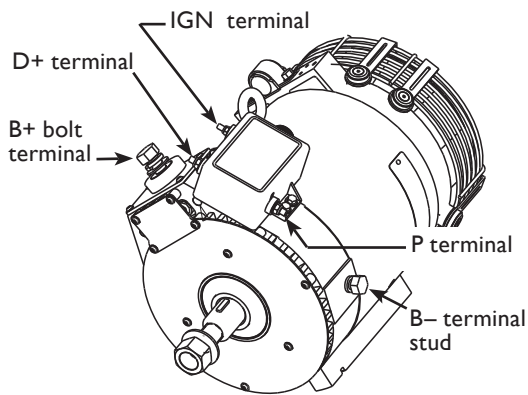

Figure 4 — C703/C703A Alternator Terminals
(Regulator Attached to Alternator)

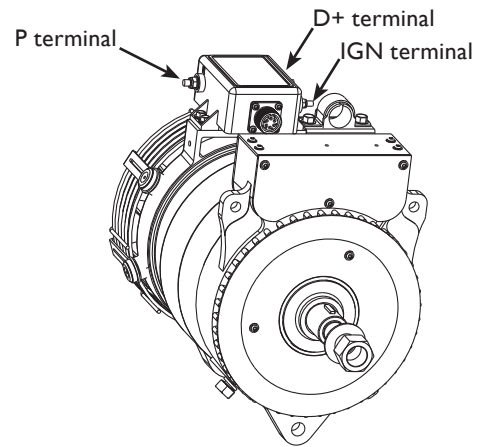

Figure 5 — C706 Alternator Terminals
(Regulator Attached to Alternator)



REMOTE-MOUNTED REGULATORS: CHECK CONDITION OF FUSE IN WIRING HARNESS BEFORE TROUBLESHOOTING

A2-214 Regulator Troubleshooting

A2-214 regulator is either attached directly to the outside of alternator or remote-mounted on the vehicle.

Main diagnostic feature is a green lens LED located on the front of the regulator. LED indicates whether regulator has been energized. See Table 3 for LED indication and status.

Regulators with OVCO (overvoltage cutout) will trip at vehicle electrical system voltages **above** 32 volts that exist longer than 3 seconds. OVCO feature detects high voltage and reacts by signaling the alternator field circuit to open. This turns off alternator. Restarting engine resets OVCO circuit. Regulator regains control of alternator output voltage.

TABLE 3 — A2-214 Regulator LED Indications and Status	
INDICATION	STATUS
ON steady	Normal regulator operation. Alternator is producing output.
FLASHING	Regulator is receiving energize signal. LED will flash until alternator produces output.
OFF	Regulator is not receiving energize signal or OVCO has tripped.

A2-325 Regulator Troubleshooting

A2-325 regulator is attached directly to the outside of alternator or mounted remotely on the vehicle.

Main diagnostic feature is a tricolored LED next to the harness receptacle on regulator. LED works like a voltmeter, measuring charging voltage. See Table 4 for diagnostic features and LED explanations.

Regulators with OVCO (overvoltage cutout) will trip at vehicle electrical system voltage above 32 volts that exists longer than 3 seconds. OVCO feature detects high voltage and reacts by signaling relay in alternator field circuit to open. This turns off alternator (LED is flashing RED—some units may flash AMBER). OVCO circuit is reset when engine is restarted. Regulator regains control of alternator output voltage.

TABLE 4 — A2-325 Regulator Diagnostics with Engine On			
LED COLOR		STATUS	ACTION
GREEN	Solid	Alternator and regulator operating normally.	No action required.
AMBER	Solid	Low system voltage — Electrical load exceeds alternator rating at present rotor speed.	When loads decrease or speed increases, LED should be solid GREEN. If not, check drive belt and charging system connections.
	Flashing	(Some models) Alternator fault — No output. (Some models) OVCO tripped.	Replace alternator. Overvoltage condition. Attempt reset. System diagnosis required. Go to page 7.
RED	Solid	High system voltage — May occur during normal load switching.	If flashing more than 3 seconds, OVCO will trip, disabling charging system. LED will flash RED.
	Flashing	OVCO tripped.	Overvoltage condition. Attempt reset. System diagnosis required. See OVCO condition in “General Troubleshooting” section on page 6.
OFF		No power to ignition or regulator is defective.	Go to Chart on page 7.



A2-341 Regulator Troubleshooting

Main diagnostic feature is a tricolored LED located on the front of the regulator. LED works like a voltmeter, measuring charging voltage. See Table 2 for LED diagnostics.

This regulator has OVCO (overvoltage cutout) that will trip at vehicle electrical system voltage above 33 volts that exists longer than 3 seconds. OVCO feature detects high voltage and reacts by signaling relay in alternator field circuit to open. This turns off alternator (LED is flashing RED). OVCO circuit is reset when engine is restarted or can also reset when system voltage normalizes after 2-minute wait.

An additional temperature-voltage sense/J1939 harness may or may not be used with the A2-341 regulator:

- When optional temperature-voltage sense/J1939 harness is not connected, regulator will operate in fixed voltage setting determined by the select switch position on the bottom of the regulator.
- When optional temperature-voltage sense/J1939 harness is connected, regulator will automatically optimize the charge voltage for battery type selected based on temperature. Also, vehicle manufacturer-requested functions of J1939 interface are available through connector.

LED COLOR		STATUS	ACTION
GREEN	Solid	Alternator and regulator operating normally.	No action required.
AMBER	Solid	Low system voltage — Electrical load exceeds alternator rating at present rotor speed.	When loads decrease or speed increases, LED should be solid GREEN. If not, check drive belt and charging system connections.
	Flashing*	Alternator fault — No output.*	Replace alternator.*
RED	Solid	High system voltage — May occur during normal load switching.	Indicates voltage above setpoint but below OVCO threshold (less than 33 volts).
	Flashing	OVCO tripped.	Indicates voltage exceeds 33 V for more than 3 seconds. System diagnosis required. See “OVCO Troubleshooting” section below.
OFF		No power to ignition or regulator is defective.	Go to Chart on page 7.

* LED will flash AMBER for one minute upon start-up/shutdown—if regulator does not sense alternator rotation, regulator will time out.

Temperature-Voltage Sense/J1939 Harness Troubleshooting

To verify temperature sense function on T-VS/J1939 harness: Apply a warm air source (such as a hair dryer, not to heat above 120°F) to battery negative terminal of harness. B+ battery voltage should decrease as temperature increases.

If voltage does not decrease: Check for a resistance reading of 5-15K Ohms across pin H in 10-pin connector on T-VS/J1939 harness and ground with meter in K Ohm scale. Then check for battery voltage across pin J on T-VS/J1939 harness and ground with meter in VDC scale. If both readings pass, go to chart on page 7. If one or both readings fail, verify proper terminal connections on B+ and B- terminal leads from T-VS/J1939 harness. If both terminal connections are good, entire harness is defective and should be replaced.

OVCO Troubleshooting

Shut down vehicle and restart engine. If alternator functions normally after restart, a “no output condition” was normal response of voltage regulator to “high voltage” condition. Inspect condition of electrical system, including loose battery cables, both positive and negative. If battery disconnects from system, it could cause “high voltage” condition in electrical system, causing OVCO circuit to trip.

If you have reset alternator once, and electrical system returns to normal charge voltage condition, there may have been a one time, high voltage spike, causing OVCO circuit to trip.

If OVCO circuit repeats cutout a second time in short succession and shuts off alternator field circuit, try third restart. If OVCO circuit repeats cutout, check that pin F in alternator-to-regulator harness is not shorted to B+ terminal on alternator and that pin A in alternator-to-regulator harness is not shorted to B-. If it is shorted, alternator is defective. If not, regulator is defective.



No Alternator Output – Test Charging Circuit

- TEST MEASUREMENTS ARE TAKEN ON HARNESS PLUG AT ALTERNATOR. TEST MEASUREMENT AT AN EXTENDED HARNESS PLUG MAY AFFECT RESULTS.
- REMOTE-MOUNTED REGULATORS: CHECK CONDITION OF FUSES IN WIRING HARNESS BEFORE TROUBLESHOOTING.
- BEFORE STARTING DIAGNOSTIC SEQUENCE, VERIFY THE FOLLOWING AND REPAIR/REPLACE IF NOT TO SPEC:
 - BATTERIES FOR STATE-OF-CHARGE (24.5-25.5 V), CONDITION, AND SECURE CONNECTIONS
 - MASTER BATTERY SWITCH FOR FUNCTION

MASTER BATTERY SWITCH ON, KEY ON, ENGINE ON: Test for battery voltage at B+ terminal on alternator to ground, then at IGN terminal on regulator to ground (A2-341 regulator: See page 2 for more information). Does battery voltage exist at both locations?

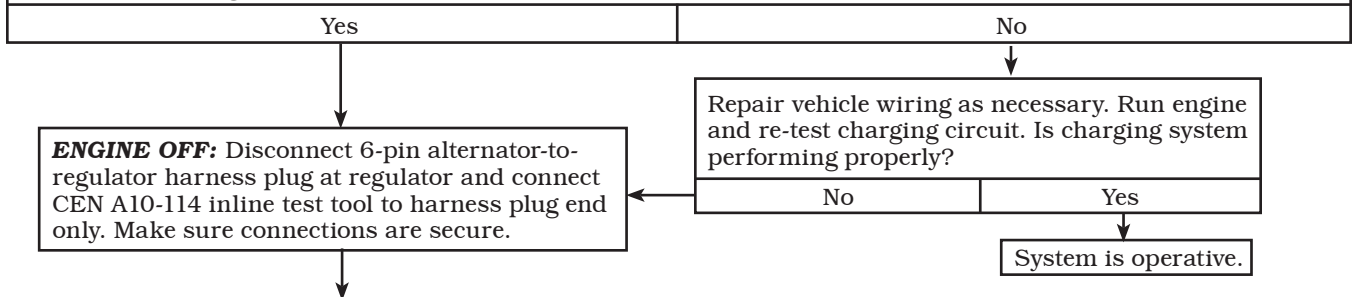

MASTER BATTERY SWITCH ON, KEY OFF, ENGINE OFF: Readings of all five tests must pass.

1. Battery voltage test: Connect DMM red lead to socket D in test tool. Connect DMM black lead to socket C in test tool. Battery voltage should exist.
2. Field coil resistance test: Set DMM to ohms test. Field resistance between sockets F and A in test tool should measure nominal $1.0-1.5 \pm 0.2$ ohms. Field coil is defective if reading is less than 0.5 ohms or greater than 3 ohms.
3. Significant magnetism test:
 - a. Securely connect one jumper wire between socket F in test tool and B+ terminal on alternator.
 - b. Insert one end of **second** jumper wire in socket A in test tool. Momentarily (1 sec.) touch other end of **second** jumper wire to alternator B- terminal. Spark will occur at B- terminal. Touch steel tool to shaft to detect significant magnetism.
 - c. Remove both jumper wires.
4. Turn off master battery switch. Disconnect B+ battery cable on alternator. **Check date code on DE housing.**
 - If date code is **before September 8, 2010**: Set DMM to diode test. Connect black lead on DMM to socket E in test tool and red lead to B+ terminal on alternator. DMM should read OL. Reverse leads. DMM should read OL again. Reconnect B+ battery cable to alternator. Turn on master battery switch.
 - If date code is **on or after September 8, 2010**: Set DMM to ohms test. Connect black lead on DMM to socket E in test tool and red lead to B+ terminal on alternator. DMM should read 0 ohms. Reverse leads. DMM should read 0 ohms again. Reconnect B+ battery cable to alternator. Turn on master battery switch.
5. Phase supply test: Set DMM to diode test. Connect DMM black lead to socket B in test tool. Connect red lead to alternator B+ terminal. DMM should read blocking in this direction. Then reverse leads. DMM should read flow in this direction. Repeat for socket B and B- terminal. Tests should read flow in one direction and blocking in the other direction.

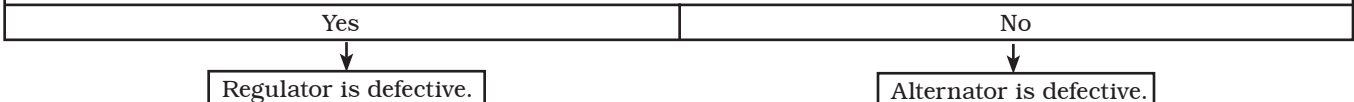

SOCKET CONNECTIONS

- Socket A F-
- Socket B Phase
- Socket C B-
- Socket D B+
- Socket E D+
- Socket F F+

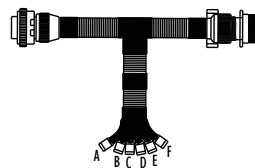

Figure 7 – CEN 6-pin A10-114 Inline Harness Tool
Socket Connections

If you have questions about your alternator or any of these instructions, or if you need to locate a Factory Authorized Service Dealer, please contact us at: