



CONTENTS

Section A: Description and Operation.....2
Section B: Basic Troubleshooting5
Section C: Advanced Troubleshooting6

Battery Charging Conditions

The following conditions may be observed during cold-start voltage tests until temperatures of electrical system components stabilize. The time it takes to reach optimum voltage and amps will vary with engine speed, load, and ambient temperature.

Maintenance/Low Maintenance Lead-Acid Battery:

Traditional lead acid batteries require lowest charge voltage of all vehicle battery chemistries. Battery cells must be maintained by periodically topping off with distilled water as required.

Maintenance-free Lead-Acid Battery:

Maintenance-free batteries are similar to Maintenance/Low Maintenance batteries, but may require slightly higher charge voltage.

Deep-cycle/Marine Maintenance-free Battery:

Charge acceptance of these batteries may display characteristics similar to maintenance-free batteries and may charge faster due to generally lower capacity relative to size.

AGM (Absorbed Glass Mat) Maintenance-free Battery:

These dry-cell batteries respond better than standard maintenance-free batteries. If battery state of charge (SOC) drops to 75% or less, batteries should be recharged to 95% or higher separately from engine charging system to avoid damaging charging system components and to provide best overall performance. Charge acceptance of these batteries may display characteristics similar to maintenance batteries, but may require higher charge voltage and will draw significant current (<100 amps) when under 50% SOC.

Lithium Battery:

Lithium batteries have unique charging characteristics that differ from lead acid. These batteries require charging systems configured specifically for lithium battery chemistries. Contact CEN for more information on lithium battery charging systems and components.

Testing Guidelines

Professional service technicians rely on the following guidelines when testing electrical components.

Voltage testing:

- Set meter to proper scale and type (AC or DC).
- Be sure to zero the meter scale or identify the meter burden by touching meter leads together. Meter burden must be subtracted from final reading obtained.
- Be sure the meter leads touch source area only. Prevent short circuit damage to test leads or source by not allowing meter leads to touch other pins or exposed wires in test area.
- Be sure to use CEN tools designed especially for troubleshooting CEN alternators when available.

Resistance (ohm) testing:

- Set meter to proper scale.
- Be sure to zero the meter scale or identify the meter burden by touching meter leads together. Meter burden must be subtracted from final reading obtained.
- Be sure meter leads touch source area only. Allowing fingers or body parts to touch meter leads or source during reading may alter reading.
- Be sure reading is taken when source is at 70°F. Readings taken at higher temperatures will increase the reading. Conversely, readings taken at lower temperatures will decrease the reading.
- Be sure to test directly at the source. Testing through extended harnesses or cable extensions may increase the reading.
- "OL" as referenced in this document refers to open circuit: "infinite" resistance, typically in very high kilo- or megaohm range depending on meter and settings.

Diode testing:

- Diodes allow current to flow in one direction only. Typical voltage drop in forward bias can range from 0.1-0.85V. Meter should read OL in reverse bias. Check meter user manual for meter-specific testing guidelines.

Voltage drop testing:

- Measure voltage between B+ on alternator or power source and B- (ground) on alternator or source. Record reading. Move to batteries or other power source and measure again between B+ and B- terminals on battery or other power source. The difference between the two readings represents voltage lost within circuit due to, but not limited to, inadequate cable gauge or faulty connections.
- Voltage drop measurements must be taken with all electrical loads or source operating.

Dynamic/Live testing (Connecting power and ground to component to test operation/function out of circuit):

- Connect jumper leads directly and securely to power source contacts of component being tested.
- Make any connection to power and ground at power supply or battery source terminals. Do not make connection at component source terminals, as that may create an arc and damage component source terminals.



C804 Alternator Description and Operation

C804 is a negative ground, cradle mount alternator rated at 28V/525A. C804 is internally rectified, and all windings and current-conducting components are non-moving, so there are no brushes or slip rings to wear out.

Voltage regulator is activated when regulator IGN terminal receives an ignition/energize signal from the vehicle, usually via oil pressure switch or multiplex system (see page 3 for regulator features). The regulator monitors alternator shaft rotation and provides field current only when it detects the alternator shaft rotating at a suitable speed.

After the regulator detects shaft rotation, it gradually applies field current, preventing an abrupt mechanical load on accessory drive system. Soft start may take up to 20 seconds after rotation and energize signals are sensed.

Refer to Figure 1 for alternator terminal locations. Refer to Figure 2 for alternator-to-regulator harness pin designations.

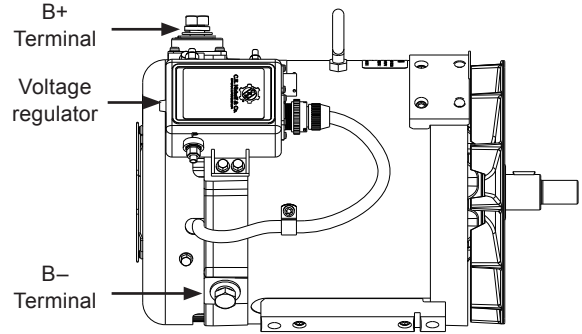
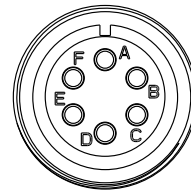

Figure 1: C804 Alternator Terminals



- A = Temp Sense
- B = Not Used
- C = B-
- D = B+
- E = Phase
- F = F+

Figure 2: Alternator-to-Regulator Harness Pin Designations

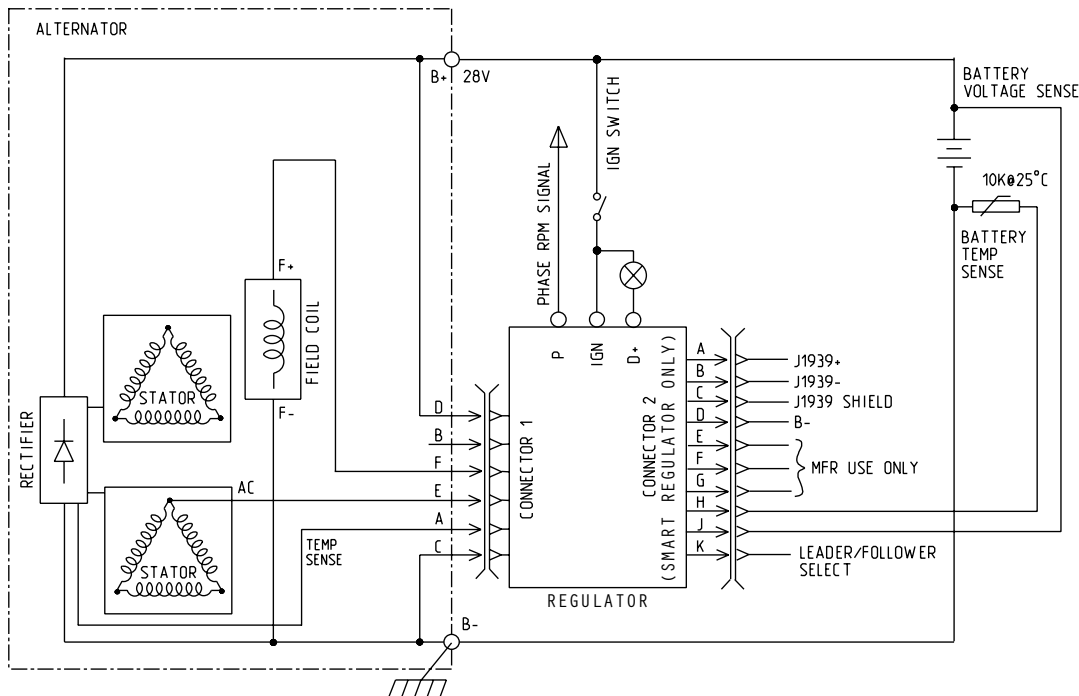

Figure 3: C804 Alternator with Regulator Wiring Diagram

(See alternator specific characteristics drawing for notes and detailed descriptions)



Section A: Description and Operation (cont)

Voltage Regulator Description and Operation

CEN voltage regulators can be mounted directly on alternator housing or remotely with compatible extension harness¹. Regulator features include:

- IGN terminal (required): Vehicle must supply battery voltage to IGN terminal to energize charging system.
- D+ output (optional): D+ circuit supplies DC battery voltage for use with charge indicator light or multiplex charge warning input.
- Phase output (optional): Phase terminal/pin taps AC voltage from alternator phase for use with relay or tachometer. Output is typically half of the output voltage at a frequency ratio of 10:1 of alternator speed.
- Adjustable voltage set points (See Table 1 below).
- Over-voltage cut out (OVCO): Regulator shuts off field switching circuit if it senses 32 volts or higher for 3 seconds or longer.

CEN Smart Regulator features also include:

- J1939 communication via 10 pin connector.
- Temperature compensation (optional): When used with compatible CEN remote harness or sensor², regulator will optimize voltage setting based on battery chemistry and compartment temperature (See Table 1 below).
- Remote voltage compensation (optional): When used with compatible CEN remote harness or sensor², regulator will boost voltage to batteries up to one volt over set point as necessary to compensate for resistive output cable losses.
- Parallel operation (optional): Alternator can be used in tandem with another compatible CEN alternator and will sync output when interconnected by A9-4045 harness or similar².
- Charging system status LED indicator (see Table 2 on page 4).

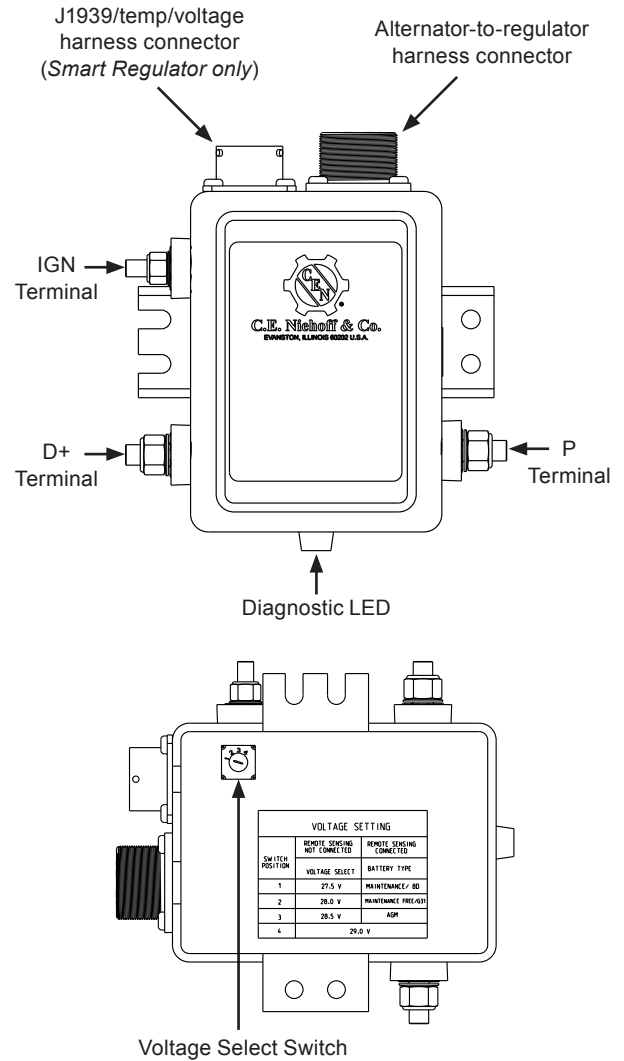

Figure 4: CEN Voltage Regulator Features

Position	Conventional Regulator Set Point or Smart Series with Sensor/Harness Not Connected	Battery profile for Smart Series Regulators with Sensor/Harness or Connected (Battery Select) ^{2,3}
1	27.5 V	Maintenance (D category)
2	28.0 V	Maintenance-free (Group 31)
3	28.5 V	AGM
4	29.0 V Flat	

1. Contact CEN for regulator extension harness options.
2. Contact CEN for sensor/harness options

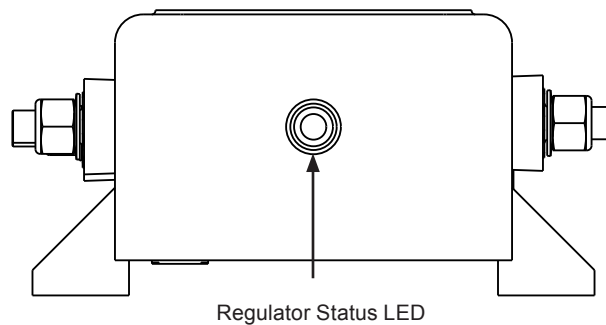

Figure 5: Regulator Status LED Location

Table 2: Regulator LED Indications		
LED COLOR	ALTERNATOR / REGULATOR STATUS	REQUIRED ACTION
GREEN (Solid)	Alternator and regulator operating normally.	No action required.
GREEN (Flashing)	Surge suppression circuit disabled; alternator still charging battery.	No action required.
AMBER (Solid)	Voltage is below 25.0 V	If voltage is at or below regulator setpoint, allow charging system to operate for several minutes to normalize operating temperature. If charge voltage does not increase within 10 minutes, go to Chart 1 on page 6.
AMBER (Flashing)	No rotation detected.	Power down and restart alternator. If LED remains flashing amber, perform troubleshooting procedures on page 6.
RED (Solid)	Field coil out of specification.	Power down and restart alternator. If LED remains solid red, perform troubleshooting procedures on page 6.
RED (Flashing)	OVCO condition detected.	Power down and restart alternator. If LED remains flashing red, refer to OVCO troubleshooting procedure on page 5.

NOTE: LED off = No power/output.

Temperature/Voltage Sense/J1939 Harness Troubleshooting (if equipped on vehicle)

To verify temperature sense function of temperature/voltage sense harness: Apply a warm air source (such as a hair dryer, not to heat above 120°F) to battery negative terminal of harness. B+ battery voltage should decrease as temperature increases. If voltage does not decrease: Check for a resistance reading of 5-15K Ohms across pin H in 10-pin connector on T-VS/J1939 harness and ground with meter in K Ohm scale.

Then check for battery voltage across pin J on temperature/voltage sense harness and ground with meter in VDC scale. If one or both readings fail, verify proper terminal connections on B+ and B- terminal leads from T-VS/J1939 harness. If both terminal connections are good, entire harness is defective and should be replaced.



Required Tools and Equipment

- Digital Multimeter (DMM)
- Ammeter (digital, inductive)
- Jumper wires

Identification Record

Enter the following information in the spaces provided for identification records.

- Alternator model number: _____
- Regulator model number: _____
- Voltage setpoints listed on regulator: _____

Preliminary Check-out

Check symptoms in Table 3 below and correct if necessary.

TABLE 3: Preliminary Charging System Check-Out	
CONDITION:	CHECK FOR:
Low Voltage Output	Low battery state of charge. Load on system exceeds rated output of alternator. Faulty wiring or poor ground path. Faulty alternator or regulator. Wrong pulley installed. Wrong regulator installed.
High Voltage Output	Faulty regulator. Faulty alternator.
No Voltage Output	No energize signal at IGN terminal on regulator. Faulty alternator B+ terminal connection. Faulty alternator or regulator.

Basic Troubleshooting

1. Inspect charging system components for damage. Check connections at B– cable, B+ cable, and regulator harness. Check regulator terminal wiring from regulator to vehicle components. Repair or replace any damaged component before electrical troubleshooting.
2. Inspect vehicle battery connections. Connections must be clean and tight.
3. Inspect belt for wear and condition.

4. Determine battery type, voltage, and state of charge. Batteries must be all the same type. If batteries are discharged, recharge or replace batteries. Electrical system cannot be properly tested unless batteries are charged 95% or higher. See page 1 for details.
5. Connect meters to alternator:
 - Connect DMM red lead to alternator B+ terminal.
 - Connect DMM black lead to alternator B– terminal.
 - Clamp inductive ammeter onto alternator B+ cable.
6. Operate vehicle and observe charge voltage. Charge voltage should increase and charge amps should decrease. Battery is considered fully charged when charge voltage is at regulator set point and charge amps remain at lowest value for 10 minutes.

If voltage is at or below regulator set point, allow charging system to operate for several minutes to normalize operating temperature. If charge voltage does not increase within 10 minutes, go to Chart 1 on page 6.

CAUTION *If voltage exceeds 32 V, shut down system immediately. Damage to electrical system may occur if charging system is allowed to operate above 32 V for more than 3 seconds.*

Check for OVCO Condition

- Shut down vehicle and restart engine. If alternator functions normally after restart, a no output condition was normal response of voltage regulator to high voltage condition.
- Inspect vehicle electrical system, including loose battery cables. If battery disconnects from system, it could cause high voltage condition in electrical system, causing OVCO circuit to trip.
- If you have reset alternator once, and electrical system returns to normal charge voltage condition, there may have been a one time, high voltage spike, causing OVCO circuit to trip.
- If OVCO circuit repeats cutout a second time in short succession and shuts off alternator, follow troubleshooting procedures in chart 2 on page 7.



Chart 1: No Alternator Output – Test Charging Circuit

- TEST MEASUREMENTS ARE TAKEN ON HARNESS PLUG AT ALTERNATOR. TAKING MEASUREMENTS FROM AN EXTENDED HARNESS PLUG MAY AFFECT RESULTS.
- FOR REMOTE-MOUNTED REGULATOR, CHECK CONDITION OF HARNESS FUSES BEFORE TROUBLESHOOTING.
- BEFORE STARTING DIAGNOSTIC SEQUENCE, VERIFY THE FOLLOWING AND REPAIR/REPLACE IF NOT TO SPEC:
 - BATTERIES FOR STATE-OF-CHARGE (25.0-28.0 V), CONDITION, AND SECURE CONNECTIONS.
 - MASTER BATTERY SWITCH FOR FUNCTION.
 - J1939 INTERCONNECT HARNESS FOR FUNCTION IF USED IN PARALLEL-OPERATION SYSTEM.

CAUTION MAKE SURE METER PROBES DO NOT TOUCH OTHER PINS AND CAUSE AN ARC THAT MAY DAMAGE PINS AND HARNESS WIRING.

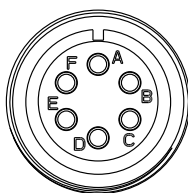
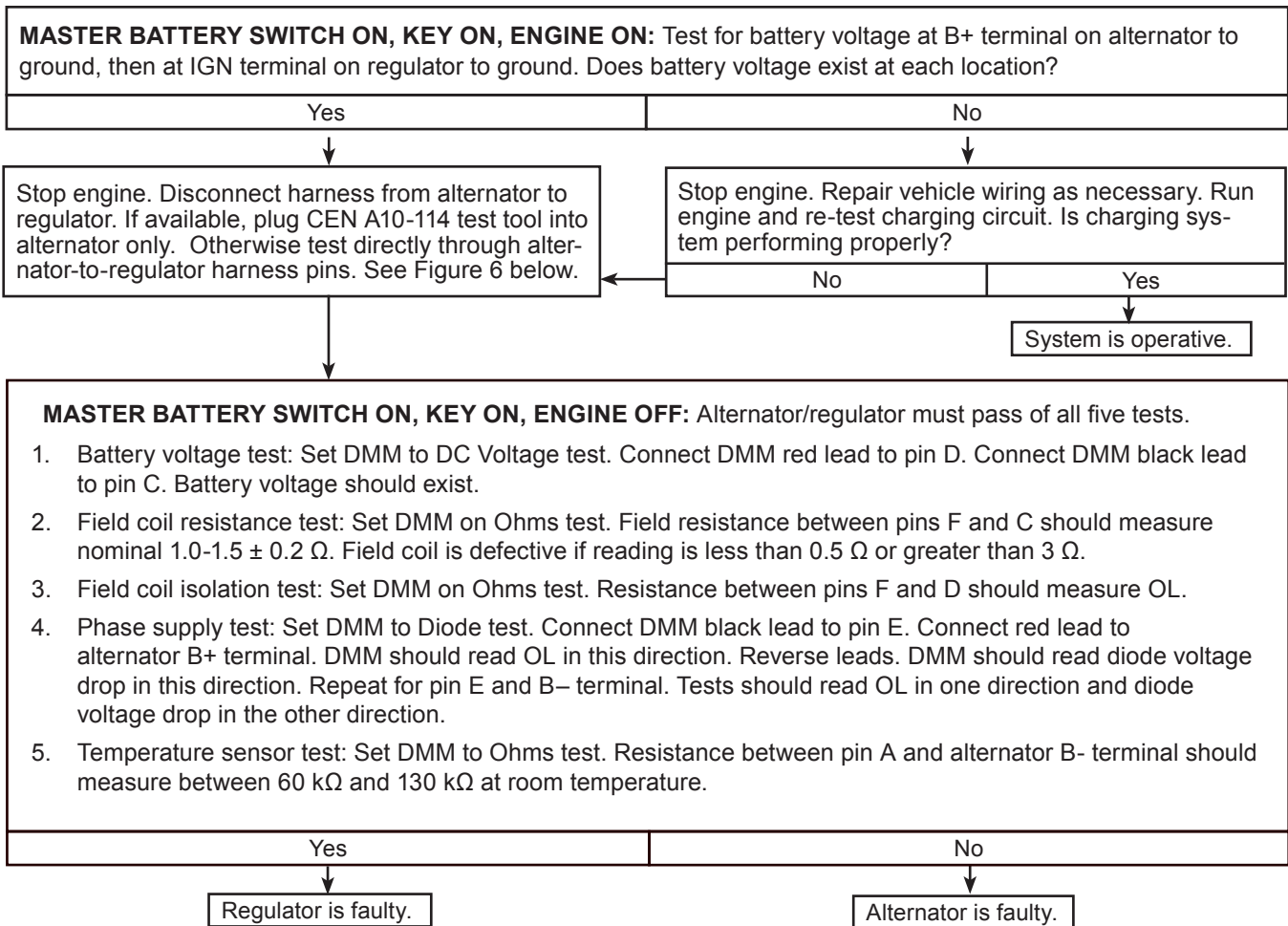

- A = Temp Sense
- B = Not Used
- C = B-
- D = B+
- E = Phase
- F = F+

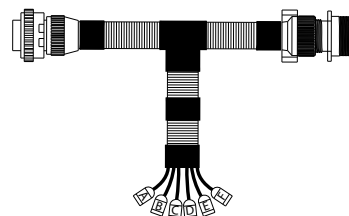
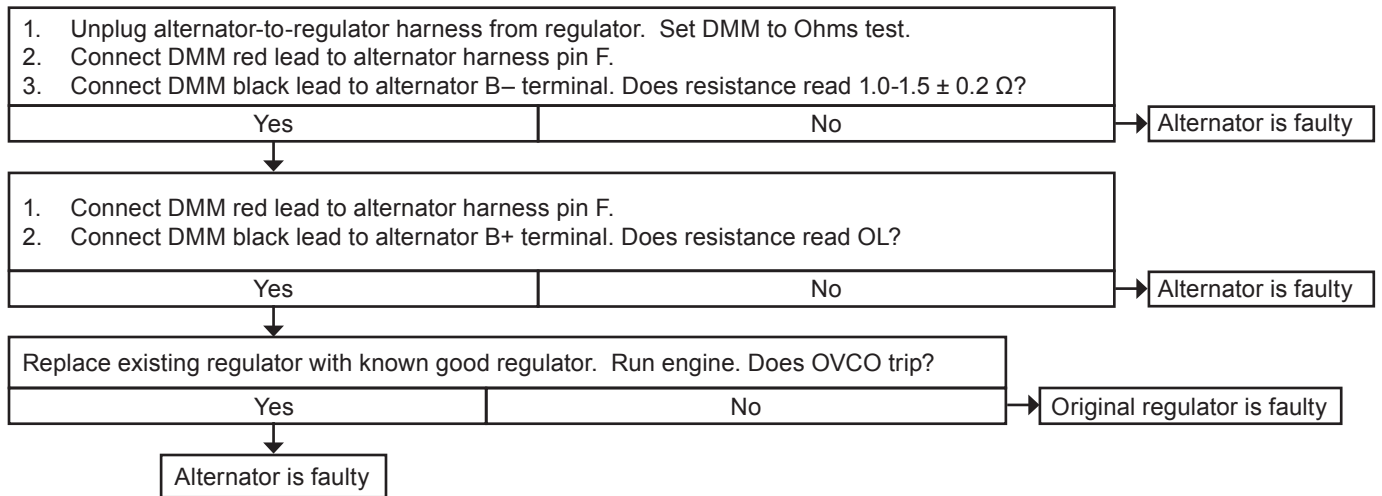

Figure 6: Alternator-to-Regulator Harness Pin Designation and Inline Harness Test Tool



Section C: Advanced Troubleshooting (CONT'D)

Chart 2: Test OVCO Circuit



If you have questions about your alternator or any of these test procedures, or if you need to locate a Factory Authorized Service Distributor, please contact us at:
C. E. Niehoff & Co. • 2021 Lee Street • Evanston, IL 60202 USA
TEL: 800.643.4633 USA and Canada • TEL: 847.866.6030 outside USA and Canada • FAX: 847.492.1242
E-mail us at service@CENiehoff.com