



Hazard Definitions

These terms are used to bring attention to presence of hazards of various risk levels or to important information concerning product life.

CAUTION

Indicates presence of hazards that will or can cause minor personal injury or property damage if ignored.

NOTICE

Indicates special instructions on installation, operation or maintenance that are important but not related to personal injury hazards.

Table of Contents

Section 1: Wiring Diagram.....	2
Section 2: Basic Troubleshooting.....	3
Section 3: Advanced Troubleshooting	4 – 6

Battery Conditions

NOTICE

Until temperatures of electrical system components stabilize, these conditions may be observed during cold start voltage tests.

- Maintenance/low maintenance battery:
 - Immediately after engine starts, system volts are lower than regulator setpoint with medium amps.
 - 3-5 minutes into charge cycle, higher system volts and reduced amps.
 - 5-10 minutes into charge cycle, system volts are at, or nearly at, regulator setpoint, and amps are reduced to a minimum.
 - Low maintenance battery has same characteristics with slightly longer recharge times.
- Maintenance-free battery:
 - Immediately after engine start, system volts are lower than regulator setpoint with low charging amps.
 - 15-30 minutes into charge cycle, still low volts and low amps.
 - 15-30 minutes into charge cycle, volts increase several tenths. Amps increase gradually, then quickly to medium to high amps.
 - 20-35 minutes into charge cycle, volts increase to setpoint and amps decrease.
- High-cycle maintenance-free battery:
 - These batteries respond better than standard maintenance-free. Charge acceptance of these batteries may display characteristics similar to maintenance batteries.

Charge Volt and Amp Values

The volt and amp levels are a function of the battery state of charge. If batteries are in a state of discharge, as after extended cranking time to start the engine, the system volts, when measured after the engine is started

will be lower than the regulator setpoint and the system amps will be high. This is a normal condition for the charging system. The measured values of system volts and amps will depend on the level of battery discharge. In other words, the greater the battery discharge level, the lower the system volts and higher the system amps will be. The volt and amp readings will change, system volts reading will increase up to regulator setpoint and the system amps will decrease to low level (depending on other loads) as the batteries recover and become fully charged.

- **Low Amps:** A minimum or lowest charging system amp value required to maintain battery state of charge, obtained when testing the charging system with a fully charged battery and no other loads applied. This value will vary with battery type.
- **Medium Amps:** A system amps value which can cause the battery temperature to rise above the adequate charging temperature within 4-8 hours of charge time. To prevent battery damage, the charge amps should be reduced when battery temperature rises. Check battery manufacturer's recommendations for proper rates of charge amps.
- **High Amps:** A system amps value which can cause the battery temperature to rise above adequate charging temperature within 2-3 hours. To prevent battery damage the charge amps should be reduced when the battery temperature rises. Check battery manufacturer's recommendations for proper rates of charge amps.
- **Battery Voltage:** Steady-state voltage value as measured with battery in open circuit with no battery load. This value relates to battery state of charge.
- **Charge Voltage:** A voltage value obtained when the charging system is operating. This value will be higher than battery voltage and must never exceed the regulator voltage setpoint.
- **B+ Voltage:** A voltage value obtained when measuring voltage at battery positive terminal or alternator B+ terminal.
- **Surface Charge:** A higher than normal battery voltage occurring when the battery is removed from a battery charger. The surface charge must be removed to determine true battery voltage and state of charge.
- **Significant Magnetism:** A change in the strength or intensity of a magnetic field present in the alternator rotor shaft when the field coil is energized. The magnetic field strength when the field coil is energized should feel stronger than when the field is not energized.
- **Voltage Droop or Sag:** A normal condition which occurs when the load demand on the alternator is greater than rated alternator output at given rotor shaft RPM.

CEN N1505-I, N1237-I, and N1225-I Dual Voltage Alternators Description and Operation

N1505-1 28 V 100 A and **N1237-1/N1225-1** 28 V 200 A alternators all with optional 28 V/14 V (50 A maximum on 14 V) are internally rectified. All windings and current-transmitting components are non-moving, so there are no brushes or slip rings to wear out.

After engine is running, **N3135** regulator receives energize signal. Regulator monitors alternator rotation and provides field current only when it detects alternator shaft rotating at suitable speed.

After regulator detects alternator rotation, it gradually applies field current, preventing an abrupt mechanical load on accessory drive system. The soft start may take up to 10 seconds at full electrical load.

N3135 regulator used with these units also

- is negative temperature compensated. Setpoints are 28.0 ± 0.2 V and 14.0 ± 0.2 V at 75° F.
- provides overvoltage cutout (OVCO). Regulator will trip OVCO when system voltage rises above 32 V in a 28 V system (16 V in a 14 V system) for longer than 2 seconds. OVCO feature detects high voltage and reacts by signaling relay in F- alternator circuit to open, turning off alternator. Restarting engine resets OVCO circuit.
- maintains alternator output voltage at regulated settings as vehicle electrical loads are switched on and off.

- can be used in single or dual voltage with these alternators.
 - Allows single-voltage operation (28 V only). 14 V is not available as a single voltage application with this regulator.
 - Provides optional 28 V/14 V output only from the regulator when phase cable from alternator is connected to regulator.

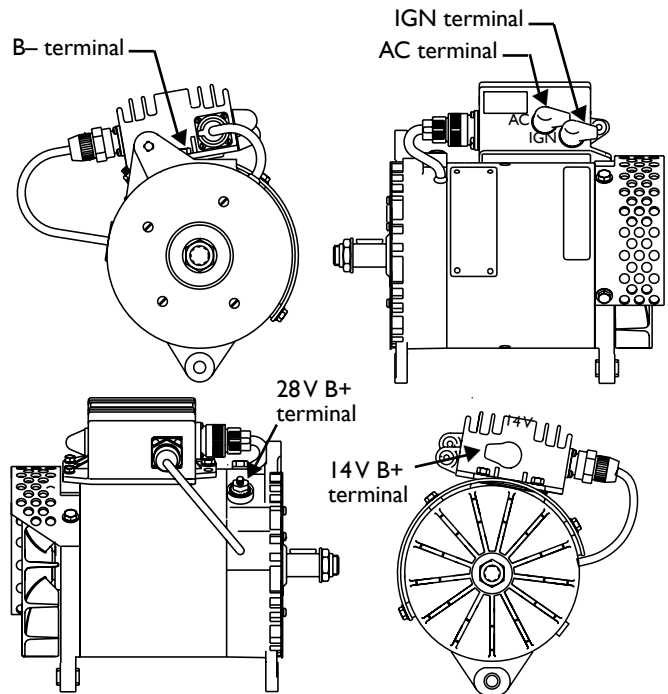


Figure 1 — N1505-I/N1237-I/N1225-I Alternators and N3135 Regulator Terminals

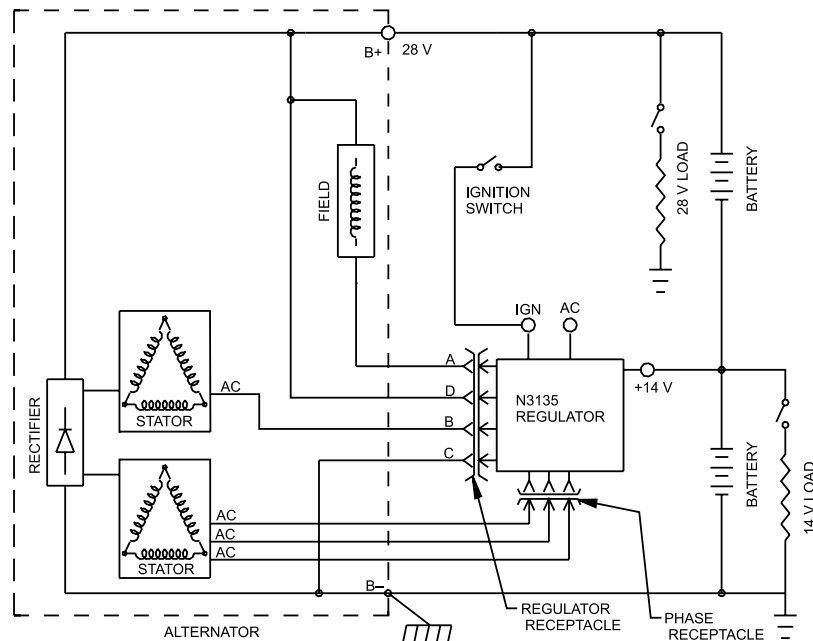


Figure 2 — N1505-I/N1237-I/N1225-I Alternators with N3135 Regulator Wiring Diagram



A. Tools and Equipment for Job

- Digital Multimeter (DMM)
- Ammeter (digital, inductive)
- Jumper wires

B. Identification Record

List the following for proper troubleshooting:

- Alternator model number _____
- Regulator model number _____
- Setpoint listed on regulator _____

C. Preliminary Check-out

Check symptoms in Table 1 and correct if necessary.

TABLE 1 – System Conditions	
SYMPTOM	ACTION
Low Voltage Output	Check: loose drive belt; low battery state of charge. Check: current load on system is greater than alternator can produce. Check: defective alternator and/or regulator.
High Voltage Output	Check: wrong regulator. Check: defective regulator. Check: alternator.
No 28 V Output	Check: presence of energize signal. Check: battery voltage at alternator output terminal. Check: defective alternator and/or regulator.
No 14 V Output	Go to Chart 2, page 5.

D. Basic Troubleshooting

- Inspect charging system components**
Check connections at ground cables, positive cables, and regulator harness. Repair or replace any damaged component before troubleshooting.
- Inspect connections of vehicle batteries**
Connections must be clean and tight.
- Determine battery type, voltage and state of charge**
Batteries must be all the same type for system operation. If batteries are discharged, recharge or replace batteries as necessary. Electrical system cannot be properly tested unless batteries are charged 95% or higher. See page 1 for details. Nominal battery voltage for 28 V systems is 25.2 ± 0.2 V; for 14 V systems is 12.6 ± 0.2 V.

Less than 25 V or 12.4 V indicates no charge condition when engine is running.

- Connect meters to alternator**
Connect red lead of DMM to alternator 28 V B+ terminal and black lead to alternator B- terminal. Clamp inductive ammeter on 28 V B+ cable.
- Operate vehicle**
Observe charge voltage at batteries with engine running (nom. 27-28 V or 13.5-14.0 V).

CAUTION

If charge voltage is above 32V for 28V system or 16V for 14V system, immediately shut down system. Electrical system damage may occur if charging system is allowed to operate at excessive voltage. Go to Table 1 at left.

If voltage is at or below regulator setpoint, let charging system operate for several minutes to normalize operating temperature.

- Observe charge volts and amps in each circuit**
Charge voltage should increase and charge amps should decrease. If charge voltage does not increase within ten minutes, continue to next step.
- Batteries** are considered fully charged if charge voltage is at regulator setpoint and charge amps remain at lowest value for 10 minutes.
- If charging system** is not performing properly, go to Chart 1, page 4.
- Check OVCO (overvoltage cutout) circuit.**
Shut down vehicle and restart engine. If alternator functions normally after restart, a “no output condition” was normal response of voltage regulator to overvoltage condition. Inspect condition of electrical system, including loose battery cables, both positive and negative. If battery disconnects from system, it could cause overvoltage condition in electrical system, causing OVCO circuit to trip.

If you have reset alternator once, and electrical system returns to normal charge voltage condition, there may have been a one time, overvoltage spike that caused OVCO circuit to trip.

If OVCO circuit repeats cutout a second time in short succession and shuts off alternator F- circuit, try third restart. If OVCO circuit repeats cutout go to Chart 3, page 6.



Chart 1 – No 28V Alternator Output – Test Charging Circuit

STATIC TEST – KEY ON, ENGINE OFF

Shut down vehicle and restart engine. Does alternator function normally after restart?

Yes	No
-----	----

Regulator responded to overvoltage condition. Go to Chart 3 on page 6 to troubleshoot OVCO.

Shut off engine. With key off, engine off: Test for battery voltage at alternator 28 V B+ terminal. Does battery voltage exist?

Yes	No
-----	----

Repair vehicle ignition circuit wiring as necessary. Continue test.

With key on, engine running: Test for battery voltage between IGN terminal on regulator and alternator B- terminal. Does 28 V battery voltage exist?

Yes	No
-----	----

Repair vehicle ignition circuit wiring as necessary. Continue test.

With key off, engine off: Remove alternator-to-regulator 4-pin harness from regulator. Test for battery voltage across sockets D and C in harness plug. Does 28 V battery voltage exist?

Yes	No
-----	----

Alternator is defective.

With DMM, check resistance across field coil. Connect red lead of DMM to socket A in alternator-to-regulator harness plug. Connect black lead to B+ terminal on alternator. Does meter show 1.8 to 2.2 ohms?

Yes	No
-----	----

Connect jumper wire from socket A in regulator harness plug to B- terminal on alternator. Spark will occur. Touch steel tool to shaft to detect significant magnetism. Is shaft magnetized?

Yes	No
-----	----

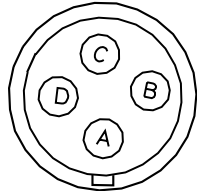
Alternator is defective.

Test phase signal into regulator (AC). Set meter to diode tester: Connect red lead of DMM to socket C of regulator harness and black lead to socket B. Meter should show voltage drop value. Then reverse meter lead connections. Meter should show OL (blocking).

Yes	No
-----	----

Regulator is defective.

Alternator is defective.

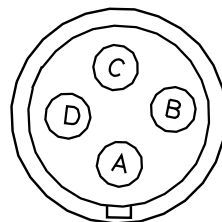
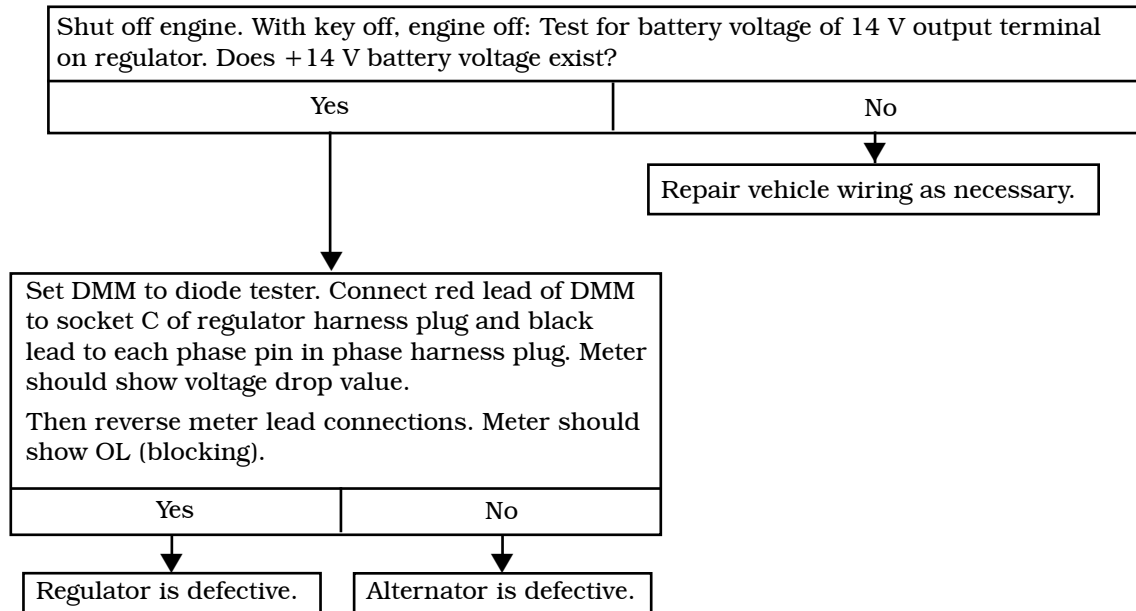


- SOCKET CONNECTIONS**
- A F-
 - B Phase Signal AC
 - C B-
 - D 28V B+

Figure 3 – Alternator-to-Regulator 4-Socket Harness Plug

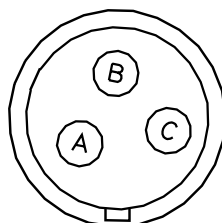


Chart 2 – No 14 V Alternator Output – Test Circuit



SOCKET CONNECTIONS
A F-
B Phase Signal AC
C B-
D 28V B+

Figure 4 – Alternator-to-Regulator 4-Socket Harness Plug



PIN CONNECTIONS
A Phase P1
B Phase P2
C Phase P3

Figure 5 – Phase Connection 3-Pin Harness Plug

Chart 3 – OVCO Trip – Determine 28 V or 14 V

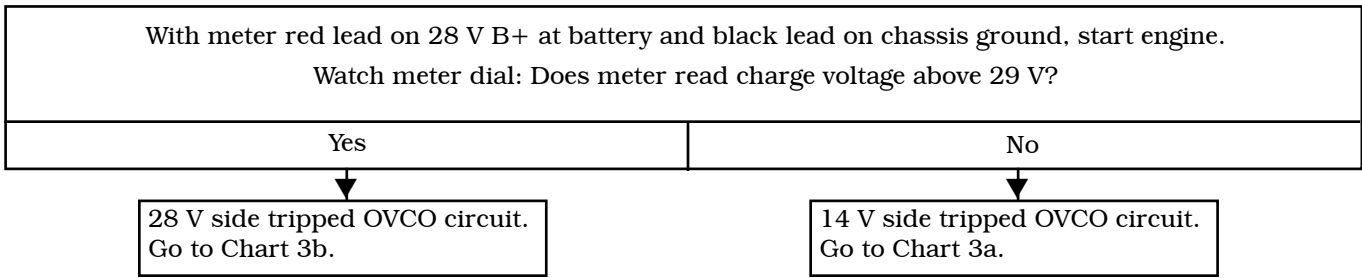


Chart 3a – No 14 V Alternator Output – Test OVCO Circuit

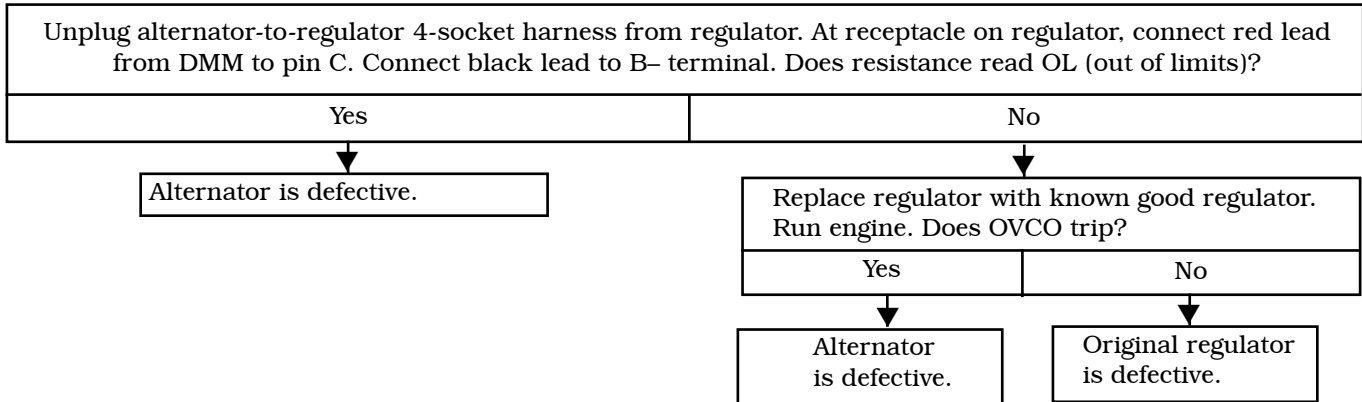


Chart 3b – No 28 V Alternator Output – Test OVCO Circuit

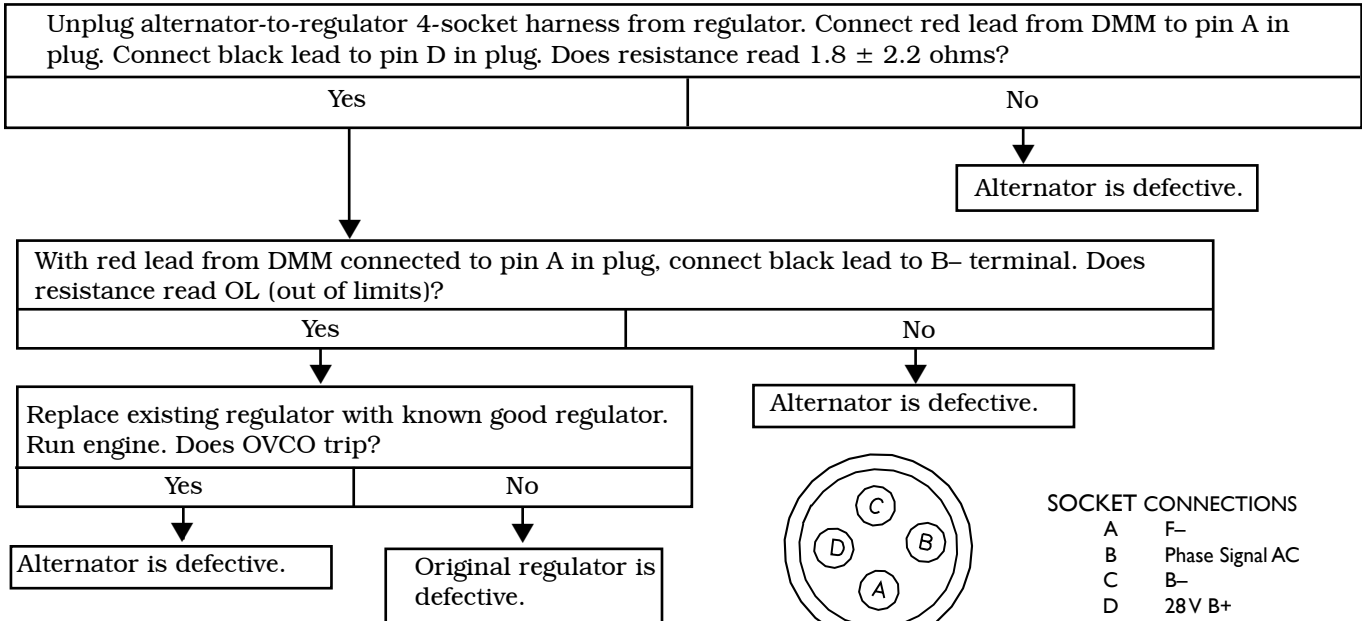


Figure 6 – Alternator-to-Regulator 4-Socket Harness Plug





If you have questions about your alternator or any of these test procedures, or if you need to locate a Factory Authorized Service Distributor, please contact us at:

C. E. Niehoff & Co. • 2021 Lee Street • Evanston, IL 60202 USA
TEL: 800.643.4633 USA and Canada • TEL: 847.866.6030 outside USA and Canada • FAX: 847.492.1242
E-mail us at support@ceniehoff.com